



# **Advanced/ML Motherboard Technical Product Specification**

Order Number 281806-002

May 1996

# Revision History

---

Revision	Revision History	Date
-001	Preliminary release of the Advanced/ML Technical Product Specification.	2/96
-002	Second release of the Advanced/ML Technical Product Specification.	5/96

This product specification applies only to standard Advanced/ML ATX motherboards with BIOS identifier 1.00.01.DB0.

Changes to this specification will be published in the Advanced/ML Motherboard Specification Update before being incorporated into a revision of this document.

Information in this document is provided in connection with Intel products. No license, express or implied, by estoppel or otherwise, to any intellectual property rights is granted by this document. Except as provided in Intel's Terms and Conditions of Sale for such products, Intel assumes no liability whatsoever, and Intel disclaims any express or implied warranty, relating to sale and/or use of Intel products including liability or warranties relating to fitness for a particular purpose, merchantability, or infringement of any patent, copyright or other intellectual property right. Intel products are not intended for use in medical, life saving, or life sustaining applications.

Intel retains the right to make changes to specifications and product descriptions at any time, without notice.

The Advanced/ML motherboard may contain design defects or errors known as errata. Current characterized errata are available on request.

Contact your local Intel sales office or your distributor to obtain the latest specifications before placing your product order.

† Third-party brands and names are the property of their respective owners.

Copies of documents which have an ordering number and are referenced in this document, or other Intel literature, may be obtained from:

Intel Corporation  
P.O. Box 7641  
Mt. Prospect, IL 60056-7641

or call in North America 1-800-879-4683, Europe 44-0-1793-431-155, France 44-0-1793-421-777,

Germany 44-0-1793-421-333, Japan (fax only) 81-0-120-478-832, other Countries 708-296-9333

Copyright © 1996, Intel Corporation

# Table of Contents

---

## 1 Motherboard Description

1.1	Overview .....	7
1.2	Motherboard Manufacturing Options.....	8
1.3	Form Factor .....	9
1.4	Microprocessor.....	9
1.4.1	Microprocessor Upgrade .....	9
1.5	Memory .....	10
1.5.1	Second-level Cache.....	10
1.5.2	Main System Memory .....	10
1.6	Chipset.....	11
1.6.1	82439HX Xcelerated Controller (TXC).....	11
1.6.2	82371SB PCI ISA/IDE Xcelerator (PIIX3).....	11
1.6.3	IDE SUPPORT.....	12
1.7	I/O Controller.....	12
1.7.1	Floppy Controller .....	12
1.7.2	Keyboard and Mouse Interface.....	13
1.7.3	Real-time Clock, CMOS RAM and Battery .....	13
1.7.4	IrDA (Infra-red) Support.....	14
1.7.5	Parallel Port .....	14
1.8	Motherboard Connectors .....	15
1.8.1	Power Supply Connectors .....	15
1.8.2	PCI IDE Header Connectors.....	16
1.8.3	Diskette Drive Header Connector .....	17
1.8.4	Front panel Connectors .....	18
1.8.5	Back Panel Connectors .....	21
1.9	Add-in Board Expansion Connectors .....	23
1.10	Jumper Settings .....	25
1.10.1	Configuration Jumper Settings .....	26
1.10.2	CPU Configuration (J7K1-B, C, D).....	26
1.10.3	Clear CMOS (J7K1-A, Pins 4,5,6) .....	27
1.10.4	Password Clear (J7K1-A, Pins 1,2,3) .....	27
1.10.5	CMOS Setup Access (J7K1-B, Pins 1,2,3) .....	27

1.10.6	VR/OVD (J7K1-B, Pins 4,5,6) .....	27
1.10.7	Program Boot Block Enable (J1F1, Pins 4,5,6) .....	27
1.10.8	Recovery Boot Enable (J1F1, Pins 1,2,3).....	27
1.11	Reliability .....	28
1.12	Environmental .....	28
1.13	Power Consumption.....	28
1.14	Regulatory Compliance.....	29
1.14.1	Safety.....	29
1.14.2	EMI .....	29
1.14.3	Product Certification Markings.....	30
1.14.4	Use Only for Intended Applications.....	30
<b>2</b>	<b>Motherboard Resources</b>	
2.1	Soft-off Control .....	32
<b>3</b>	<b>Motherboard BIOS and Setup Utilities</b>	
3.1	Introduction .....	35
3.2	BIOS Flash Memory Organization .....	35
3.3	BIOS Upgrades .....	35
3.4	PCI IDE Support.....	36
3.5	PCI Auto-configuration .....	36
3.6	ISA Plug and Play .....	37
3.7	Advanced Power Management .....	37
3.8	Language Support.....	37
3.9	Boot Options .....	38
3.10	Flash LOGO Area .....	38
3.11	Setup Enable Jumper.....	38
3.12	BIOS Setup Utility.....	38
3.12.1	Overview of the Setup Menu Screens .....	38
3.12.2	Main BIOS Setup Screen.....	39
3.12.3	Floppy Options Subscreen .....	40
3.12.4	Hard Disk Configuration Subscreen.....	41
3.12.5	Boot Options Subscreen.....	42
3.12.6	Advanced Screen .....	43
3.12.7	Peripheral Configuration Subscreen.....	44
3.12.8	Advanced Chipset Configuration Subscreen .....	45

3.12.9	Power Management Configuration Subscreen .....	46
3.12.10	Plug and Play Configuration Subscreen .....	46
3.12.11	Security Screen .....	47
3.12.12	Security Screen Options .....	48
3.12.13	Exit Screen .....	49
<b>4</b>	<b>Error Messages and Beep Codes</b>	
4.1	BIOS Beep Codes .....	51
4.2	PCI Configuration Error Messages .....	51
4.3	BIOS Error Messages .....	52
4.4	ISA NMI Messages .....	53



# 1 Motherboard Description

---

## 1.1 Overview

The ATX motherboard integrates the Pentium<sup>®</sup> microprocessor, memory, and I/O technologies into a standard ATX form factor.

The motherboard design supports Pentium processors operating at 75, 90, 100, 120, 133, 150, and 166 MHz. The other motherboard features include:

- Supports up to 128 MB of EDO DRAM or standard Fast Page DRAM in standard 72-pin SIMM<sup>†</sup> sockets, either parity, non-parity, or ECC.
- Type 7 Pentium OverDrive<sup>®</sup> socket provides an upgrade to future OverDrive processors.
- Intel's 82430HX PCIset.
- PC87306B Super I/O controller.
- Bus mastering IDE.
- Supports Plug and Play and Advanced Power Management (APM).

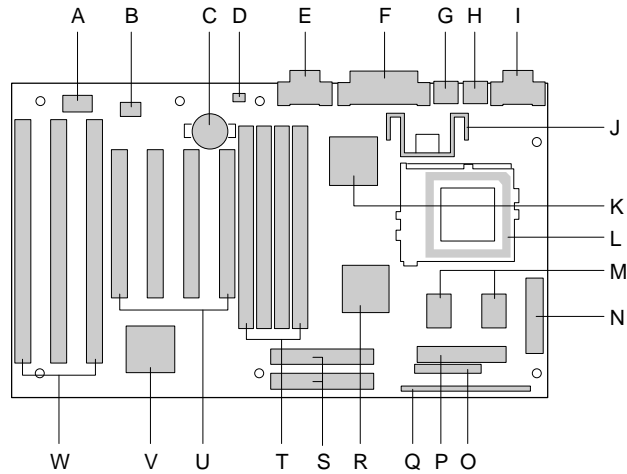

OM04289A

**Figure 1. Motherboard Features**

- |                             |                               |
|-----------------------------|-------------------------------|
| A. Flash memory device      | M. SRAM sites                 |
| B. MB PLCC flash            | N. Primary power connector    |
| C. Clock battery            | O. Configuration jumper block |
| D. Recovery jumper          | P. Floppy connector           |
| E. COM1 serial port         | Q. Front panel connector      |
| F. Parallel port connector  | R. BGA 82430HX                |
| G. PS/2 keyboard connector  | S. IDE connectors             |
| H. PS/2 mouse connector     | T. SIMM sockets               |
| I. COM2 serial port         | U. PCI add-in connectors      |
| J. Voltage regulator        | V. PIIX3                      |
| K. I/O controller           | W. ISA add-in connectors      |
| L. Pentium processor socket |                               |

## 1.2 Motherboard Manufacturing Options

- 256 or 512 KB pipeline burst SRAM cache
- Support for Universal Serial Bus (USB)



### 1.3 Form Factor

The motherboard is designed to fit into a standard ATX form factor chassis. Figure 2 illustrates the mechanical form factor for the motherboard. The ATX form factor does not adhere to the standard ATX guidelines in that the outer dimensions are 12" x 7". Location of the I/O connectors, riser slot, and mounting holes are in strict compliance with the ATX specification.

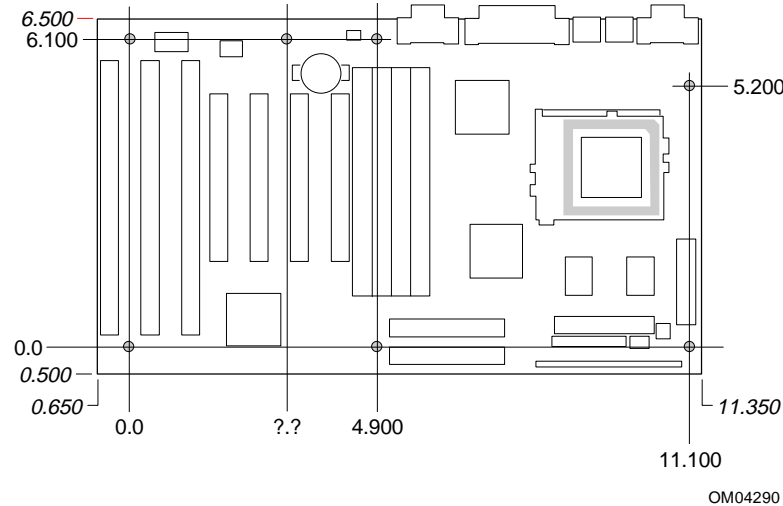

Figure 2. Motherboard Dimensions

### 1.4 Microprocessor

The motherboard is designed to operate with 3.3 volt Pentium Processors. An onboard linear voltage regulator circuit provides the required 3.3 volts from the 5.0 volt tap of the power supply. An on-board jumper enables use of VRE specified processors. Pentium processors that run internally at 75, 90, 100, 120, 133, 150 and 166 MHz are supported.

The Pentium processor maintains full backward compatibility with the 8086, 80286, i386™ and Intel486™ processors. It supports both read and write burst mode bus cycles, and includes separate 8 KB on-chip code and data caches that employ a write-back policy. The Pentium processor is an advanced numeric coprocessor that significantly increases the speed of floating point operations, while maintaining backward compatibility with i486DX math coprocessor and complying to ANSI/IEEE standard 754-1985.

#### 1.4.1 Microprocessor Upgrade

The motherboard provides a 321-pin Socket 7 ZIF processor socket. Socket 7 supports a processor upgrade path that includes higher performance Pentium OverDrive processors than can be supported with socket 5.

## 1.5 Memory

### 1.5.1 Second-level Cache

The Intel 82430HX Xcelerated Controller PCIset supports a second level cache that uses the Synchronous Pipeline Burst SRAM. Pipeline Burst (PB) SRAM provides performance similar to Synchronous Burst SRAMs for only a slight cost premium over slower performing Asynchronous SRAMs.

Data SRAM speed is 15 ns that supports up to 66 MHz processor (external) bus speed.

### 1.5.2 Main System Memory

The motherboard provides four 72-pin SIMM sockets that make it possible to install up to 128 MB of RAM. The sockets support 1M x 32 (4 MB), 2M x 32 (8 MB), 4M x 32 (16 MB), and 8M x 32 (32 MB) single- or double-sided modules. Minimum memory size is 8 MB and maximum memory size, using four 8M x 32 SIMM modules, is 128 MB. Memory timing requires 70 ns fast page devices or, for optimum performance, 60 ns EDO DRAM. If the maximum external CPU clock speed is 60 MHz or slower, 70 ns EDO DRAM may be used. Either parity or non-parity memory SIMMs are supported. ECC SIMMs are also supported.

The four sockets are arranged in two banks of two sockets each. The sockets are designated Bank 0 and Bank 1. Each bank provides a 64/72-bit wide data path. Both SIMMs in a bank must be of the same memory size and type, although the different types of memory may differ between banks. It is even possible to have 70 ns Fast Page DRAM in one bank and 60 ns EDO DRAM in the other, in that case each bank is independently optimized for maximum performance. Bank 0 only, Bank 1 only, or both of the banks may be populated. There are no jumper settings required for the memory size or type, that is automatically detected by the system BIOS. Use only tin lead SIMMs when adding DRAM.

#### 1.5.2.1 EDO DRAM

Extended Data Out (or Hyper Page) DRAM is designed to improve the DRAM read performance. EDO DRAM holds the memory data valid until the next memory access cycle, unlike standard fast page mode DRAM that tri-states the memory data when the precharge cycle occurs, prior to the next memory access cycle.

## 1.6 Chipset

The Intel 82430HX PCIset consists of the 82439HX Xcelerated Controller (TXC) and one 82371SB PCI ISA/IDE Xcelerator (PIIX3) bridge chip.

### 1.6.1 82439HX Xcelerated Controller (TXC)

The 82439HX provides all control signals necessary to drive a second level cache and the DRAM array, including multiplexed address signals. The TXC also controls system access to memory and generates snoop controls to maintain cache coherency. The TXC comes in a 324-pin BGA package and includes the following features:

- CPU interface control
- Integrated L2 write-back cache controller
  - Pipeline burst SRAM
  - 256 or 512 KB direct-mapped
- Integrated DRAM controller
  - 64 bit path to memory
  - Support for EDO and fast page DRAM
  - 8 MB to 128 MB main memory
  - Parity and non-parity support
- Fully synchronous PCI bus interface
  - 25/30/33 MHz
  - PCI to DRAM > 100 Mbytes/sec
  - Up to 4 PCI masters in addition to the PIIX3 and IDE.

### 1.6.2 82371SB PCI ISA/IDE Xcelerator (PIIX3)

The PIIX3 provides the interface between the PCI and ISA buses and integrates a dual channel fast IDE interface capable of supporting up to 4 devices. The PIIX3 integrates seven 32-bit DMA channels, one 16-bit timer/counters, two eight-channel interrupt controllers, PCI-to-AT interrupt mapping circuitry, NMI logic, ISA refresh address generation, and PCI/ISA bus arbitration circuitry together onto the same device. The PIIX3 comes in a 208-pin QFP package and includes the following features.

- Interface between the PCI and ISA buses
- Universal Serial Bus controller
  - Host/hub controller
- Integrated fast IDE interface
  - Support for up to 4 devices
  - PIO Mode 4 transfers up to 16 MB/sec
  - Integrated 8 x 32-bit buffer for bus master PCI IDE burst transfers
  - Bus master mode
- PCI 2.1 compliant
- Enhanced fast DMA controller
- Interrupt controller and steering
- Counters/timers
- SMI interrupt logic and timer with fast on/off mode

### 1.6.3 IDE SUPPORT

The motherboard provides two independent high performance bus-mastering PCI IDE interfaces capable of supporting PIO Mode 3 and Mode 4 devices. The system BIOS supports Logical Block Addressing (LBA) and Extended Cylinder Sector Head (ECHS) translation modes as well as ATAPI (e.g. CD-ROM) devices on both IDE interfaces. Detection of IDE device transfer rate and translation mode capability is automatically determined by the system BIOS.

Normally, programmed I/O operations require a substantial amount of CPU bandwidth. In true multi-tasking operating systems like Windows<sup>†</sup> 95, the CPU bandwidth freed up by using bus mastering IDE can be used to complete other tasks while disk transfers are occurring. When used in conjunction with the appropriate driver for the Windows 95 environment, the IDE interface can operate as a PCI bus master capable of supporting PIO Mode 4 PIO Mode 4 devices with transfer rates of up to 16 MB/sec.

Detailed information on the PCIset is available in the Intel 82430HX PCIset data sheet

## 1.7 I/O Controller

Control for the integrated serial ports, parallel port, floppy drive, RTC and keyboard controller is incorporated into a single component, the National Semiconductor 306B. This component provides:

- Two NS16C550-compatible UARTs with send/receive 16 byte FIFO
- Support for an IrDA<sup>†</sup> compliant Infra Red interface
- Multi-mode bi-directional parallel port
  - Standard mode; IBM<sup>†</sup> and Centronics<sup>†</sup> compatible
  - Enhanced Parallel Port (EPP) with BIOS/Driver support
  - High Speed mode; Extended Capabilities Port (ECP) compatible
- Industry standard floppy controller with 16 byte data FIFO (2.88 MB floppy support)
- Integrated Real Time Clock accurate within +/- 13 minutes/yr at 25° C and 5 volts when the system is continuously powered on
- Integrated 8042 compatible keyboard controller

By default, the 306B interfaces are automatically configured by the BIOS during boot-up. You can also manually configure the interfaces with the BIOS Setup utility. Chapter 3 describes and tells how to invoke the BIOS Setup utility.

### 1.7.1 Floppy Controller

The I/O controller is software compatible with the DP8473 and 82077 floppy disk controllers. You can configure the floppy interface for 360 KB or 1.2 MB 5¼ inch media or for 720 KB, 1.2 MB, 1.44 MB, or 2.88 MB 3½ inch media with the BIOS setup utility. By default, the Floppy A interface is configured for 1.44 MB and Floppy B is disabled. A Setup option makes it possible to prevent a user from being able to write to a floppy drive. A driver is required for configuring the floppy interface for 1.2 MB 3.5-inch (3-mode floppy) operation.

## 1.7.2 Keyboard and Mouse Interface

PS/2<sup>†</sup> keyboard and mouse connectors are located on the back panel side of the motherboard. The 5V lines to these connectors are protected with a PolySwitch<sup>†</sup> circuit that acts much like a self-healing fuse, re-establishing the connection after an over-current condition is removed. While this device eliminates the possibility of having to replace a fuse, you should still be sure to turn off the system power before installing or removing a keyboard or mouse.

The integrated 8042 microcontroller contains the AMI Megakey keyboard and mouse controller code that, besides providing traditional keyboard and mouse control functions, supports Power-On/Reset (POR) password protection. The POR password can be defined by the user via the Setup program. The keyboard controller also provides for the following "hot key" sequences:

- <CTRL><ALT><DEL>: System software reset. This sequence performs a software reset of the system by jumping to the beginning of the BIOS code and running the POST operation.
- <CTRL><ALT><+> and <CTRL><ALT><->: Turbo mode selection.
- <CTRL><ALT><-> sets the system for de-turbo mode, emulating an 23 MHz AT.
- <CTRL><ALT><+> sets the system for turbo mode. Changing the Turbo mode may be prohibited by an operating system, or when the CPU is in Protected mode or virtual x86 mode under DOS.
- <CTRL><ALT><defined in setup>: Power down and coffee-break key sequences take advantage of the SMM capabilities of the Pentium processor to greatly reduce the system's power consumption while maintaining the responsiveness necessary to service external interrupts.
- <CTRL><ALT><defined in setup>: Keyboard lock key sequence provides system security by blanking the screen and ignoring keyboard input until the BIOS User Password is typed. When the Keyboard lock sequence is invoked, the keyboard LEDs will flash to indicate that the User Password must be entered to unlock the system. This feature will not take effect unless the User Password has been set in the BIOS setup.

## 1.7.3 Real-time Clock, CMOS RAM and Battery

The integrated real-time clock (RTC) is DS1287 and MC146818 compatible and provides a time of day clock, 100-year calendar with alarm features and is accurate to within 13 minutes per year. The RTC can be set via the BIOS SETUP program. The RTC also supports 242-byte battery-backed CMOS RAM in two banks which is reserved for BIOS use. The CMOS RAM can be set to specific values or cleared to the system default values using the BIOS SETUP program. Also, the CMOS RAM values can be cleared to the system defaults by using a configuration jumper on the motherboard.

An external coin-cell style battery provides power to the RTC and CMOS memory. The battery has an estimated lifetime of three years if the system is not plugged into the wall socket. When the system is plugged in, power is supplied from the ATX power supply's 5v standby current to extend the life of the battery.

### **1.7.4 IrDA (Infra-red) Support**

A 5-pin header connector is provided to allow connection to a Hewlett Packard HSDSL-1000 compatible Infra-red (IrDA) transmitter/receiver. Once the module is connected to the header, Serial port 2 can be re-directed to the IrDA module. Once configured for IrDA, the user can transfer files to or from portable devices such as laptops, PDA's and printers using application software such as LapLink<sup>†</sup>. The IrDA specification provides for data transfers at 115 Kbps from a distance of 1 meter.

### **1.7.5 Parallel Port**

The Parallel port can be configured in the BIOS setup as output only compatible mode, bi-directional mode, ECP or EPP modes. The highly flexible parallel port can also be assigned to I/O addresses 278H, 378H, or 3BCH and IRQ's 5 or 7. Furthermore, a routable DMA scheme allows Plug and Play operating systems such as Windows 95 to route either DMA channels 1 or 3 to the parallel port for ECP mode. EPP BIOS support must be provided by a device driver or TSR.

## 1.8 Motherboard Connectors

There are connectors on-board for Floppy, IDE, SIMMs, battery holder and front panel I/O connectors. Pinouts for the motherboard connectors follow Figure 3.

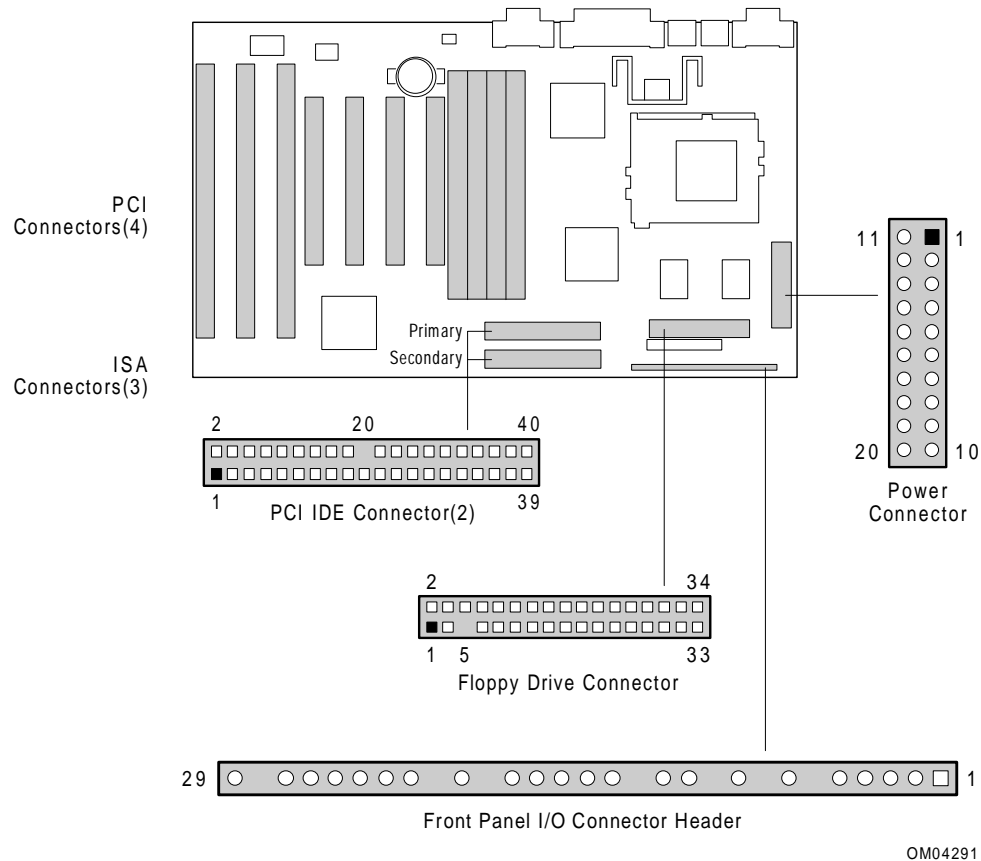

**Figure 3. Motherboard Connector Locations**

### 1.8.1 Power Supply Connectors

When used with a power supply that supports remote power on/off, the motherboard can turn off the system power via software control (“soft-off” is a manufacturing option). The Powerman utility supplied for Windows 3.1x allows for soft-off as does the shutdown icon in Windows 95 Start menu. The system BIOS will turn the system power off when it receives the proper APM command from the OS. For example, Windows 95 will issue this APM command when the user selects “Shutdown the computer” option. APM must be enabled in the system BIOS and OS in order for the soft-off feature to work correctly. In order for the system to recognize the presence of a “soft-off” power supply, the supply must tie pin 14 of the PWS Control connector to ground. If power to the system is interrupted due to a power outage or the power cord being unplugged, when power is reapplied, the system will return to the state it was in when the power was disconnected. If the system was turned on when power was disconnected, the system will turn back on when power is reapplied.

**Primary Power Connector (J6M1)**

Pin	Name	Function
1	3.3V	3.3V
2	3.3V	3.3V
3	GND	Ground
4	+5 V	+ 5 volts Vcc
5	GND	Ground
6	+5 V	+ 5 volts Vcc
7	GND	Ground
8	PWRGD	Power Good
9	5VSB	standby 5v
10	+12 V	+ 12 volts
11	3.3V	3.3V
12	-12 V	- 12 volts
13	GND	Ground
14	PS_ON*	soft-off control
15	GND	Ground
16	GND	Ground
17	GND	Ground
18	-5 V	- 5 volts
19	+5 V	+ 5 volts Vcc
20	+5 V	+ 5 volts Vcc

**1.8.2 PCI IDE Header Connectors**

**IDE Connector Pinout**

Pin	Signal Name	Pin	Signal Name
1	Reset IDE	2	Ground
3	Host Data 7	4	Host Data 8
5	Host Data 6	6	Host Data 9
7	Host Data 5	8	Host Data 10
9	Host Data 4	10	Host Data 11
11	Host Data 3	12	Host Data 12
13	Host Data 2	14	Host Data 13
15	Host Data 1	16	Host Data 14
17	Host Data 0	18	Host Data 15
19	Ground	20	Key
21	DRQ3	22	Ground

continued ➡



**IDE Connector Pinout (continued)**

Pin	Signal Name	Pin	Signal Name
23	I/O Write-	24	Ground
25	I/O Read-	26	Ground
27	IOCHRDY	28	BALE
29	DACK3-	30	Ground
31	IRQ14	32	IOCS16-
33	Addr 1	34	Ground
35	Addr 0	32	Addr 2
37	Chip Select 0-	38	Chip Select 1-
39	Activity	40	Ground

**1.8.3 Diskette Drive Header Connector****Diskette Drive Connector Pinout**

Pin	Signal Name	Pin	Signal Name
1	Ground	2	FDHDIN
3	Ground	4	Reserved
5	Key	6	FDEDIN
7	Ground	8	Index-
9	Ground	10	Motor Enable A-
11	Ground	12	Drive Select B-
13	Ground	14	Drive Select A-
15	Ground	16	Motor Enable B-
17	Ground	18	DIR-
19	Ground	20	STEP-
21	Ground	22	Write Data-
23	Ground	24	Write Gate-
25	Ground	26	Track 00-
27	Ground	28	Write Protect-
29	Ground	30	Read Data-
31	Ground	32	Side 1 Select-
33	Ground	34	Diskette Change-

### 1.8.4 Front panel Connectors

The motherboard provides header connectors to support functions typically located on the chassis bezel. Front panel features supported include:

- System Reset
- Power LED
- Hard Drive activity LED
- System Speaker
- CPU fan
- Infra-red (IrDA) port
- Sleep/Resume

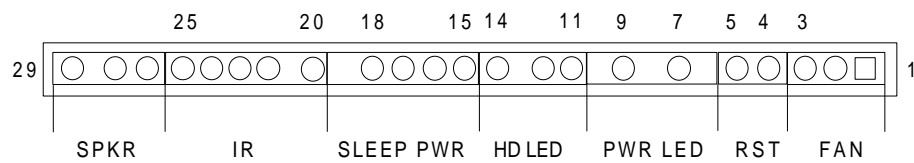

OM04520

Figure 4. Front Panel I/O Connectors

#### 1.8.4.1 Speaker

The external speaker provides error beep code information during the Power-on Self Test, if the system cannot use the video interface.

##### Speaker Connector Pinout

Pin	Signal Name
26	SPKR_DAT
27	SPKR_DAT
28	Key
29	Ground

### 1.8.4.2 Infra-red (IrDA) connector

Serial port 2 can be configured to support an IrDA module via a 5 pin header connector. Once configured for IrDA, the user can transfer files to or from portable devices such as laptops, PDA's and printers using application software such as LapLink. The IrDA specification provides for data transfers at 115 Kbps from a distance of 1 meter.

#### Infrared Connector Pinout

Pin	Signal Name
20	+5 V
21	no connect
22	IRRX
23	Ground
24	IRTX
25	no connect

### 1.8.4.3 Sleep / Resume

When Advanced Power Management (APM) is activated in the system BIOS and the Operating System's APM driver is loaded, Sleep mode (Stand-by) can be entered in one of three ways: an optional front panel "Sleep/Resume" button, a user defined keyboard hot key, or prolonged system inactivity. The Sleep/Resume button is supported by a 2-pin header located on the front panel I/O connector. Closing the "Sleep" switch will generate an SMI (System Management Interrupt) to the processor which immediately goes into System Management Mode (SMM), the so called "Sleep" mode.

The front panel "Sleep mode" switch must be a momentary two pin SPST type that is normally open. The function of the Sleep/Resume button can also be achieved via a keyboard hot-key sequence, or by a time-out of the system inactivity timer. Both the keyboard hot-key and the inactivity timer are programmable in the BIOS setup (timer is set to 10 minutes by default). To re-activate the system, or "Resume", the user must simply press the sleep/resume button again, or use the keyboard or mouse. Mouse activity will only "wake up" the system if a mouse driver is loaded. While the system is in Stand-by or "sleep" mode it is fully capable of responding to and servicing external interrupts (such as in-coming FAX) even though the monitor will only turn on if a user interrupt (keyboard/mouse) occurs as mentioned above.

#### Sleep/Power Connector Pinout

Pin	Signal Name
15	SW_ON*
16	Ground
17	COMATOSE *
18	+5 V

### 1.8.4.4 Hard Drive LED

**Hard Drive LED Connector Pinout**

Pin	Signal Name
11	+5 V
12	HDA*
13	PWR_LED_DRV
14	+5 V

### 1.8.4.5 Power LED

**Power LED Connector Pinout**

Pin	Signal Name
7	+5 V
8	+5 V
9	PWR_LED_DRV
10	PWR_LED_DRV

### 1.8.4.6 Reset

This 2-pin header can be connected to a momentary SPST type switch that is normally open. When the switch is closed, the system will hard reset and run POST.

**Reset Connector Pinout**

Pin	Signal Name
4	Ground
5	SW_RST

### 1.8.4.7 Fan

**CPU Fan Connector Pinout**

Pin	Signal Name
1	Ground
2	+12 V
3	Ground

## 1.8.5 Back Panel Connectors

The back panel provides external access to PS/2 style keyboard and mouse connectors as well as two serial and one parallel port, which are integrated on the motherboard. Figure 5 shows the general location of the I/O connectors.

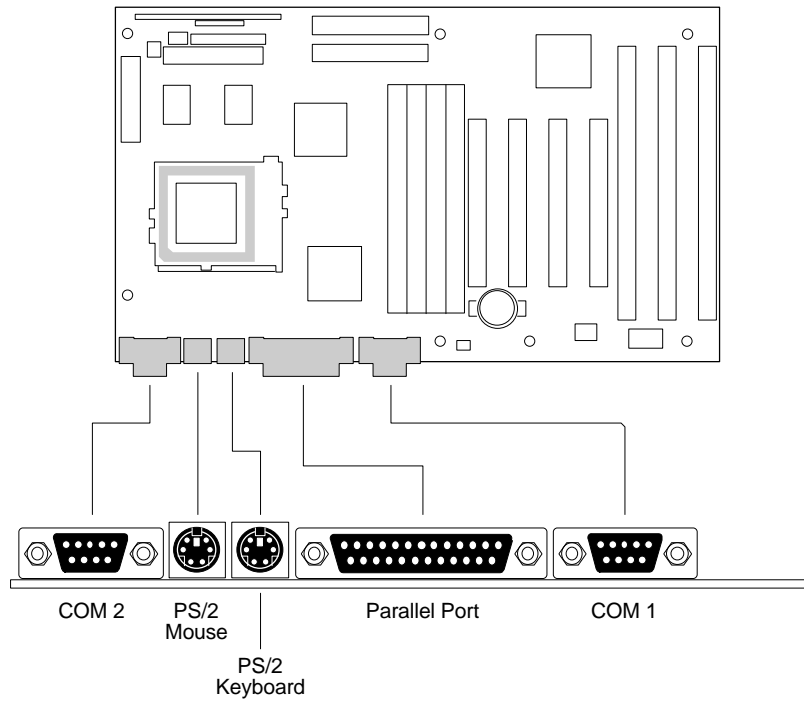

OM04292

Figure 5. I/O Connections

### 1.8.5.1 COM1 and 2 Serial Ports

#### Serial Port Connector Pinout

Pin	Signal Name
1	DCD
2	Serial In - (SIN)
3	Serial Out - (SOUT)
4	DTR
5	GND
6	DSR
7	RTS
8	CTS
9	RI

### 1.8.5.2 Keyboard and Mouse Ports

#### Keyboard and Mouse Connector Pinouts

Pin	Signal Name
1	Data
2	No connect
3	Ground
4	+5 V (fused)
5	Clock
6	No Connect

### 1.8.5.3 Parallel Port

#### Parallel Port Connector Pinout

Pin	Signal Name	Pin	Signal Name
1	Strobe-	14	Auto Feed--
2	Data Bit 0	15	Fault*
3	Data Bit 1	16	INIT*
4	Data Bit 2	17	SLCT IN*
5	Data Bit 3	18	Ground
6	Data Bit 4	19	Ground
7	Data Bit 5	20	Ground
8	Data Bit 6	21	Ground
9	Data Bit 7	22	Ground
10	ACK*	23	Ground
11	Busy	24	Ground
12	Paper end	25	Ground
13	SLCT		

## 1.9 Add-in Board Expansion Connectors

Expansion Slots support up to four PCI and up to three ISA add-in boards. The PCI bus is fully compliant with the PCI 2.1 specification and supports up to four bus master through the four PCI connectors.

### PCI Slots (J4E1,J4E2,J4C1,J4D1)

Pin	Signal Name	Pin	Signal Name	Pin	Signal Name	Pin	Signal Name
A1	Vcc	B1	-12V	A32	AD16	B32	AD17
A2	+12V	B2	GND	A33	3.3V	B33	CBE2 #
A3	Vcc	B3	GND	A34	FRAME #	B34	GND
A4	Vcc	B4	No Connect	A35	GND	B35	IRDY #
A5	Vcc	B5	Vcc	A32	TRDY #	B32	3.3V
A6	PIRQ1 #	B6	Vcc	A37	GND	B37	DEVSEL #
A7	PIRQ3 #	B7	PIRQ2 #	A38	STOP #	B38	GND
A8	Vcc	B8	PIRQ0 #	A39	3.3V	B39	LOCK #
A9	No Connect	B9	PRSNT1B#	A40	SDONE	B40	PERR #
A10	Vcc	B10	No Connect	A41	SBO #	B41	3.3V
A11	No Connect	B11	PRSNT2B#	A42	GND	B42	SERR #
A12	GND	B12	GND	A43	PAR	B43	3.3V
A13	GND	B13	GND	A44	AD15	B44	CBE1 #
A14	No Connect	B14	No Connect	A45	3.3V	B45	AD14
A15	RST #	B15	GND	A46	AD13	B46	GND
A16	Vcc	B16	PCLK3	A47	AD11	B47	AD12
A17	GNT1 #	B17	GND	A48	GND	B48	AD10
A18	GND	B18	REQ #	A49	AD9	B49	GND
A19	Reserved	B19	Vcc	A50	KEY	B50	KEY
A20	AD30	B20	AD31	A51	KEY	B51	KEY
A21	3.3V	B21	AD29	A52	CBEO #	B52	AD8
A22	AD28	B22	GND	A53	3.3V	B53	AD7
A23	AD26	B23	AD27	A54	AD6	B54	3.3V
A24	GND	B24	AD25	A55	AD4	B55	AD5
A25	AD24	B25	3.3V	A56	GND	B56	AD3
A26	AD25 (IDSEL)	B26	CBE3 #	A57	AD2	B57	GND
A27	3.3V	B27	AD23	A58	AD0	B58	AD1
A28	AD22	B28	GND	A59	Vcc	B59	Vcc
A29	AD20	B29	AD21	A60	REQ64 #	B60	ACK64 #
A30	GND	B30	AD19	A61	Vcc	B61	Vcc
A31	AD18	B31	3.3V	A62	Vcc	B62	Vcc

**ISA Slots (J4A1, J4B1, J4B2)**

Pin	Signal Name	Pin	Signal Name	Pin	Signal Name	Pin	Signal Name
A1	IOCHK-	B1	GND	A26	SA5	B26	DACK2-
A2	SD7	B2	RSTSLOT	A27	SA4	B27	TC
A3	SD6	B3	Vcc	A28	SA3	B28	BALE
A4	SD5	B4	IRQB9	A29	SA2	B29	Vcc
A5	SD4	B5	-5V	A30	SA1	B30	OSC
A6	SD3	B6	DREQ2	A31	SA0	B31	GND
A7	SD2	B7	-12V	C1	SBHE-	D1	MEMCS16-
A8	SD1	B8	ZEROWS-	C2	LA23	D2	IOCS16-
A9	SD0	B9	+12V	C3	LA22	D3	IRQB10
A10	IOCHRDY	B10	GND	C4	LA21	D4	IRQB11
A11	AEN	B11	SMEMW-	C5	LA20	D5	IRQB12
A12	SA19	B12	SMEMR-	C6	LA19	D6	IRQ15
A13	SA18	B13	IOW-	C7	LA18	D7	IRQ14
A14	SA17	B14	IOR-	C8	LA17	D8	DACK0-
A15	SA16	B15	DACK3-	C9	MEMR-	D9	DREQ0
A16	SA15	B16	DREQ3	C10	MEMW-	D10	DACK5-
A17	SA14	B17	DACK1-	C11	SD8	D11	DREQ5
A18	SA13	B18	DREQ1	C12	SD9	D12	DACK6-
A19	SA12	B19	REFRESH-	C13	SD10	D13	DREQ6
A20	SA11	B20	SYSCLK	C14	SD11	D14	DACK7-
A21	SA10	B21	IRQA7	C15	SD12	D15	DREQ7
A22	SA9	B22	IRQA6	C16	SD13	D16	Vcc
A23	SA8	B23	IRQA5	C17	SD14	D17	MASTER-
A24	SA7	B24	IRQA4	C18	SD15	D18	GND
A25	SA6	B25	IRQA3				



## 1.10 Jumper Settings

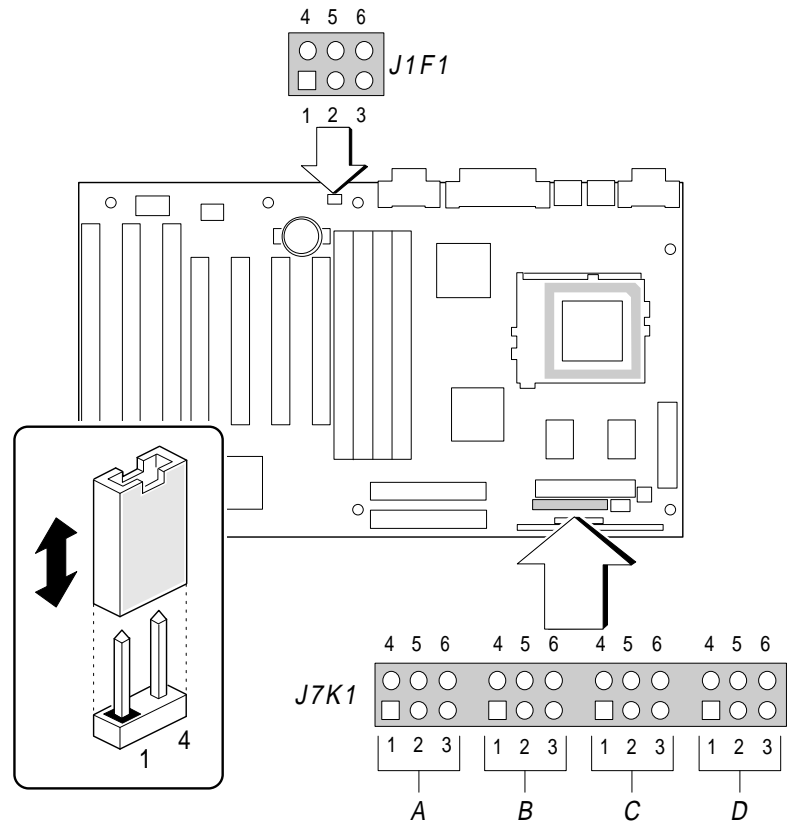

OM04293

Figure 6. Jumper Locations

### 1.10.1 Configuration Jumper Settings

These jumpers allow you to set the basic motherboard configuration.

**Table 1. Configuration Jumper Settings**

Function	Jumper	Configuration
CMOS Clear	J7K1-A	4-5 Keep <b>(Default)</b> 5-6 Clear
Password Clear	J7K1-A	1-2 Password Enabled <b>(Default)</b> 2-3 Password Clear/Disabled
CMOS Setup Access	J7K1-B	* 1-2 Access Allowed <b>(Default)</b> 2-3 Access Denied
VRE/OVD	J7K1-B	4-5 VRE <b>(Default)</b> 5-6 OVD  <b>CAUTION: This jumper should not be changed unless changing to a new processor type.</b>

### 1.10.2 CPU Configuration (J7K1-B, C, D)

These jumpers allow the motherboard to be switched between different speeds of the Pentium processor. These jumpers also affect the PCI and ISA clock speeds according to the following table.

**Table 2. CPU/SYSTEM Speed Settings**

CPU Freq. (MHz)	Host Bus Freq. (MHz)	J7K1-C	K7K1-D	CPU Clock Multiplier
166	66	1-2,5-6	2-3,5-6	2.5
150	60	2-3,4-5	2-3,5-6	2.5
133	66	1-2,5-6	2-3,4-5	2
120	60	2-3,4-5	2-3,4-5	2
100	66	1-2,5-6	1-2,4-5	1.5
90	60	2-3,4-5	1-2,4-5	1.5
75	50	2-3,5-6	1-2,4-5	1.5
reserved	-	2-3,5-6	1-2,5-6	
reserved	-	2-3,4-5	1-2,5-6	
reserved	-	1-2,5-6	1-2,5-6	

### 1.10.3 Clear CMOS (J7K1-A, Pins 4,5,6)

Allows CMOS settings to be reset to default values by moving the jumper from pins 4-5 to pins 5-6 and turning the system on. When the system reports that “NVRAM cleared by jumper”, the system can be turned off, and the jumper should be returned to the 4-5 position to restore normal operation. This procedure should be done whenever the system BIOS is updated. Default is for this jumper to be on pins 4-5.

### 1.10.4 Password Clear (J7K1-A, Pins 1,2,3)

Allows system password to be cleared by moving the jumper from pins 1-2 to pins 2-3 and turning the system on. The system should then be turned off and the jumper should be returned to the 3-5 position to restore normal operation. This procedure should only be done if the user password has been forgotten. The password function is effectively disabled if this jumper is in the 1-3 position. Default is for the password to be enabled (3-5 position).

### 1.10.5 CMOS Setup Access (J7K1-B, Pins 1,2,3)

Allows access to CMOS Setup utility to be disabled by moving this jumper from the 1-2 position to the 2-3 position. Default is for access to setup to be enabled (1-2 position)

### 1.10.6 VR/OVD (J7K1-B, Pins 4,5,6)

This jumper block changes the output of the on-board voltage regulator. The default setting (pins 4-5) should be jumpered for processors that require the VR specification (3.3 V.). Pins 5-6 should be jumpered for OverDrive processors. Check the microprocessor's documentation for the correct setting. This jumper should not be changed by the user unless changing to a new processor type.

### 1.10.7 Program Boot Block Enable (J1F1, Pins 4,5,6)

This jumper allows the boot block to be programmed when set to Program (pins 5-6). The default setting is Protect (pins 4-5).



#### **CAUTION**

*Changing this jumper and reprogramming the boot block could cause unreliable operation.*

### 1.10.8 Recovery Boot Enable (J1F1, Pins 1,2,3)

This jumper allows the BIOS to be recovered if it has been corrupted. To set the jumper to Recover, move the jumper from pins 1-2 to pins 2-3. Default setting is for Normal operation (pins 1-2).

## 1.11 Reliability

The Mean-time-Between-Failures (MTBF) data is calculated from predicted data @ 55C.

Motherboard 109,302 hours

## 1.12 Environmental

**Table 3. Motherboard Environmental Specifications**

Parameter	Specification
<b>Temperature</b>	
Non-operating	-40°C to +70°C
Operating	+0°C to +55°C
<b>Vibration</b>	
Unpackaged	5 Hz to 20 Hz : 0.01g <sup>2</sup> Hz sloping up to 0.02 g <sup>2</sup> Hz
	20 Hz to 500 Hz : 0.02g <sup>2</sup> Hz (flat)
Packaged	10 Hz to 40 Hz : 0.015g <sup>2</sup> Hz (flat)
	40 Hz to 500 Hz : 0.015g <sup>2</sup> Hz sloping down to 0.00015 g <sup>2</sup> Hz

## 1.13 Power Consumption

Tables 4 and 5 list the voltage and current specifications for a hypothetical system configured with the motherboard and the following components: a 133 MHz Pentium Processor, 8 MB RAM, 256 KB cache, 3.5-inch floppy drive, 540 MB hard drive and running at the DOS prompt. This information is provided only as a guide for calculating **approximate** total system power usage with additional resources added.

**Table 4. DC Voltage**

DC Voltage	Acceptable Tolerance
+5V	+/- 5%
+5V SB (stand by)	+/- 5%
-5V	+/- 5%
+12V	+/- 5%
-12V	+/- 5%

**Table 5. Power Usage**

	AC (watts)	DC (milliamps)			
		+5 V	-5 V	+12 V	-12 V
No APM enabled					
DOS prompt	35	980	0	200	30
APM enabled					
DOS prompt	20				

## 1.14 Regulatory Compliance

This printed circuit assembly complies with the following safety and EMI regulations when correctly installed in a compatible host system.

### 1.14.1 Safety

#### 1.14.1.1 UL 1950 - CSA 950-95, 3rd edition, Dated 3-28-95

The Standard for Safety of Information Technology Equipment including Electrical Business Equipment. (USA & Canada).

#### 1.14.1.2 CSA C22.2 No. 950-93, 3rd Edition

The Standard for Safety of Information Technology Equipment including Electrical Business Equipment. (Canada)

#### 1.14.1.3 EN 60 950, 2nd Edition, 1992 (with Amendments. 1, 2 & 3)

The Standard for Safety of Information Technology Equipment including Electrical Business Equipment. (European Union)

#### 1.14.1.4 IEC 950, 2nd edition, 1991 (with Amendments 1, 2 & 3)

The Standard for Safety of Information Technology Equipment including Electrical Business Equipment. (International)

#### 1.14.1.5 EMKO-TSE (74-SEC) 207/94

Summary of Nordic deviations to EN 60 950. (Norway, Sweden, Denmark & Finland)

### 1.14.2 EMI

#### 1.14.2.1 FCC Class B

Title 47 of the Code of Federal Regulations, Parts 2 & 15, Subpart B, pertaining to unintentional radiators. (USA)

#### **1.14.2.2 CISPR 22, 2nd Edition, 1993**

Limits and methods of measurement of Radio Interference Characteristics of Information Technology Equipment. (International)

#### **1.14.2.3 EN 55 022, 1995**

Limits and methods of measurement of Radio Interference Characteristics of Information Technology Equipment. (Europe)

#### **1.14.2.4 EN 50 082-1 (1992)**

Generic Immunity Standard; Currently compliance is determined via testing to IEC 801-2, -3 and -4. (Europe)

#### **1.14.2.5 VCCI Class 2 (ITE)**

Implementation Regulations for Voluntary Control of Radio Interference by Data Processing Equipment and Electronic Office Machines. (Japan)

#### **1.14.2.6 ICES-003, Issue 2**

Interference-Causing Equipment Standard, Digital Apparatus. (Canada)

### **1.14.3 Product Certification Markings**

This printed circuit assembly has the following product certification markings:

- European CE Marking: Consists of a marking on the board or shipping container.
- UL Recognition Mark: Consists of the UL File No. E139761 on the component side of the board and the PBA No. on the solder side of the board. Board material flammability is 94V-1 or -0.
- Canadian Compliance: Consists of small c followed by a stylized backward UR on component side of board.

### **1.14.4 Use Only for Intended Applications**

This product was evaluated for use in systems that will be installed in offices, homes, schools, computer rooms or similar applications. Other applications, such as medical, industrial, alarm systems and test equipment may necessitate a re-evaluation of the product suitability.

## 2 Motherboard Resources

**Table 6. Memory Map**

Address Range (Decimal)	Address Range (hex)	Size	Description
960K-131072K	100000-8000000	127.25M	Extended Memory
944K-959K	FE000-FFFFF	8K	Boot Block (erasable only if jumpered)
936K-943K	FD000-FDFFF	4K	ESCD (Plug and Play configuration area)
928K-935K	FC000-FCFFF	4K	OEM LOGO & Vital Product Data Area
896K-927K	E0000-FBFFF	112K	AMI System BIOS
800-895K	C8000-DFFFF	96K	Available HI DOS memory (open to ISA and PCI bus)
640K-799K	A0000-C7FFF	160K	Off-board video memory and BIOS
639K	9FC00-9FFFF	1K	Extended BIOS Data (moveable by QEMM, 386MAX)
512K-638K	80000-9FBFF	127K	Extended conventional
0K-511K	00000-7FFFF	512K	Conventional

**Table 7. I/O Map**

Address (hex)	Size	Description	Address (hex)	Size	Description
0000 - 000F	16 bytes	PIIX3 - DMA 1	0278 - 027B	4 bytes	Parallel Port 2
0020 - 0021	2 bytes	PIIX3 - Interrupt Controller 1	02F8 - 02FF	8 bytes	On-Board Serial Port 2
002E - 002F	2 bytes	87306B Base Configuration	0376	1 byte	Sec IDE Chan Cmd Port
0040 - 0043	4 bytes	PIIX3 - Timer 1	0377	1 byte	Sec IDE Chan Stat Port
0060	1 byte	Keyboard Controller Byte - Reset IRQ	0378 - 037F	8 bytes	Parallel Port 1
0061	1 byte	PIIX3 - NMI, speaker control	03BC - 03BF	4 bytes	Parallel Port 3
0064	1 byte	Kbd Controller, CMD/STAT Byte	03E8 - 03EF	8 bytes	Serial Port 3
0070, bit 7	1 bit	PIIX3 - Enable NMI	03F0 - 03F5	6 bytes	Floppy Channel 1
0070, bits 6:0	7 bits	PIIX3 - Real Time Clock, Address	03F6	1 byte	Pri IDE Chan Cmd Port
0071	1 byte	PIIX3 - Real Time Clock, Data	03F7 (Write)	1 byte	Floppy Chan 1 Cmd

continued 

**Table 7. I/O Map (continued)**

Address (hex)	Size	Description	Address (hex)	Size	Description
0078	1 byte	Reserved - Brd. Config.	03F7, bit 7	1 bit	Floppy Disk Chg Chan 1
0079	1 byte	Reserved - Brd. Config.	03F7, bits 6:0	7 bits	Pri IDE Chan Status Port
0080 - 008F	16 bytes	PIIX3 - DMA Page Register	03F8 - 03FF	8 bytes	On-board Serial Port 1
00A0 - 00A1	2 bytes	PIIX3 - Interrupt Controller 2	04D0 - 04D1	2 bytes	Edge/level triggered
00B2	1 byte	APM control port	LPT + 400h	8 bytes	ECP port, LPT + 400h
00B3	1 byte	APM status port			
00C0 - 00DE	31 bytes	PIIX3 - DMA 2	0CF8 - 0CFB*	4 bytes	PCI Config Address Reg.
00F0	1 byte	Reset Numeric Error	0CFC-0CFF*	4 bytes	PCI Config Data Reg
0170 - 0177	8 bytes	Secondary IDE Channel	FF00 - FF07	8 bytes	IDE Bus Master Reg.
01F0 - 01F7	8 bytes	Primary IDE Channel			

\* Only by DWORD accesses.

## 2.1 Soft-off Control

The motherboard design supports Soft-off control via the SMM code in the BIOS. This feature is a manufacturing option. The CS1 pinout of the I/O controller is connected to the Soft-off control line in the power supply circuit. The registers in the I/O controller that set the I/O address and control of the CS1 pin are NOT setup until the SMM code is activated. The code performs the following operations:

- OUT 0Ch to I/O port 2Eh
- OUT 75h to I/O port 2Fh
- OUT 11h to I/O port 2Eh
- OUT 00h to I/O port 2Fh
- OUT 0Dh to I/O port 2Eh
- OUT A0h to I/O port 2Fh

After setting the above registers, any read operation to I/O location 75H will trigger the Soft-off circuit and turn the power supply off.



**Table 8. PCI Configuration Space Map**

<b>Bus Number (hex)</b>	<b>Dev Number (hex)</b>	<b>Function Number (hex)</b>	<b>Description</b>
00	00	00	Intel 82437HX (TXC)
00	07	00	Intel 82371SB (PIIX3 ) PCI/ISA bridge
00	07	01	Intel 82371SB (PIIX3 ) IDE Bus Master
00	0D	00	PCI Expansion Slot: J4E2
00	0E	00	PCI Expansion Slot: J4E1
00	0F	00	PCI Expansion Slot: J4D1
00	10	00	PCI Expansion Slot: J4C1

**Table 9. DMA Channels**

<b>DMA</b>	<b>Data Width</b>	<b>System Resource</b>
0	8- or 16-bits	
1	8- or 16-bits	Parallel Port
2	8- or 16-bits	Floppy
3	8- or 16-bits	Parallel Port (for ECP/EPP Config.)
4		Reserved - Cascade channel
5	16-bits	Open
6	16-bits	Open
7	16-bits	Open

**Table 10. Interrupts**

<b>IRQ</b>	<b>System Resource</b>
NMI	I/O Channel Check
0	Reserved, Interval Timer
1	Reserved, Keyboard buffer full
2	Reserved, Cascade interrupt from slave PIC
3	Serial Port 2
4	Serial Port 1
5	Parallel Port 1 (PNP0 option)
6	Floppy
7	Parallel Port 1
8	Real Time Clock
9	User available
10	User available
11	User available
12	Onboard Mouse Port if present, else user available
13	Reserved, Math coprocessor
14	Primary IDE if present, else user available
15	Secondary IDE if present, else user available

# 3 Motherboard BIOS and Setup Utility

---

## 3.1 Introduction

The motherboard uses an Intel BIOS, which is stored in Flash EEPROM and easily upgraded using a floppy disk-based program. In addition to the Intel BIOS, the Flash EEPROM also contains the Setup utility, Power-on Self Tests (POST), APM 1.1, the PCI auto-configuration utility, and Windows 95 ready Plug and Play. This motherboard also supports system BIOS shadowing, allowing the BIOS to execute from 64-bit on-board write-protected DRAM.

The BIOS displays a sign-on message during POST identifying the type of BIOS and a five-digit revision code. The initial production BIOS in the motherboard will be identified as 1.00.01.DB0.

Information on BIOS functions can be found in the IBM PS/2 and Personal Computer BIOS Technical Reference published by IBM, and the ISA and EISA Hi-Flex AMIBIOS Technical Reference published by AMI. Both manuals are available at most technical bookstores.

## 3.2 BIOS Flash Memory Organization

The Intel PA28FB100BX 1 Mb Flash component is organized as 128K x 8 (128 KB). The Flash device is divided into four areas, as described in Table 11.

**Table 11. Flash Memory Organization**

System Address		FLASH Memory Area
FE000H	FFFFFFH	8 KB Boot Block (erasable only if jumpered)
FD000H	FDFFFFH	4 KB Plug and Play ESCD Storage Area
FC000H	FCFFFFH	4 KB Custom LOGO and Vital Product Data
E0000H	FBFFFFH	112 KB System BIOS Reserved during boot

## 3.3 BIOS Upgrades

Flash memory makes distributing BIOS upgrades easy. A new version of the BIOS can be installed from a diskette. BIOS upgrades are available to be down loaded from the secure section on the Intel bulletin board, or Intel's FTP site, or call your local Intel sales office.

The disk-based Flash upgrade utility, FMUP.EXE, has three options for BIOS upgrades:

- The Flash BIOS can be updated from a file on a disk;
- The current BIOS code can be copied from the Flash EEPROM to a disk file as a backup in the event that an upgrade cannot be successfully completed; or
- The BIOS in the Flash device can be compared with a file to ensure the system has the correct version.

The upgrade utility ensures the upgrade BIOS extension matches the target system to prevent accidentally installing a BIOS for a different type of system.

### 3.4 PCI IDE Support

The two local bus IDE connectors with independent I/O channel support are setup up automatically by the BIOS if the user selects “Autoconfiguration” in setup. The IDE interface supports PIO Mode 3, and Mode 4 hard drives and recognition of ATAPI CD-ROMs, tape drives, and any other ATAPI devices. The BIOS will determine the capabilities of each drive and configure them to optimize capacity and performance. For the high capacity hard drives typically available today, the drive will be automatically be configured for Logical Block Addressing (LBA) for maximum capacity and to PIO Mode 3 or 4 depending on the capability of the drive. The user is able to override the auto-configuration options by using the manual mode setting. The ATAPI Specification Revision 2.5 recommends that an ATAPI device be configured as shown in the table below.

**Table 12. Recommendations for Configuring an ATAPI Device**

Primary Cable		Secondary Cable		
Drive 0	Drive 1	Drive 0	Drive 1	
ATA				Normal, no ATAPI
ATA		ATAPI		Disk and CD-ROM for enhanced IDE systems
ATA	ATAPI			Legacy IDE System with only one cable
ATA		ATAPI	ATAPI	Enhanced IDE with CD-ROM and a tape or two CD-ROMs

### 3.5 PCI Auto-configuration

The PCI auto-configuration utility operates in conjunction with the system Setup utility to allow the insertion and removal of PCI cards to the system without user intervention (Plug and Play). When the system is turned on after adding a PCI add-in card, the BIOS automatically configures interrupts, I/O space, and other parameters. PCI interrupts are distributed to available ISA interrupts that have been not been assigned to an ISA card, or system resources. Those interrupts left set to “available” in the CMOS setup will be considered free for PCI add-in card use. It is nondeterministic as to which PCI interrupt will be assigned to which ISA IRQ.

The PCI auto-configuration function complies with version 2.10 of the PCI BIOS specification. System configuration information is stored in ESCD format. The ESCD data may be cleared by setting the CMOS clear jumper to the ON position.

PCI specification 2.1 for add-in card auto-configuration is also a part of the Plug and Play BIOS. Peer-to-peer hierarchical PCI Bridge 1.0 is supported, and by using an OEM supplied option ROM or TSR, a PCI-to-PCMCIA bridge capability is possible as well.

### 3.6 ISA Plug and Play

The BIOS incorporates ISA Plug and Play capabilities as delivered by Plug and Play Release 1.0A (Plug and Play BIOS V.. 1.0A, ESCD V.. 1.03). When used in conjunction with the ISA Configuration Utility (ICU) for DOS or Windows 3.x, the system allows auto-configuration of Plug and Play ISA cards, PCI cards, and resource management for legacy ISA cards. Because the BIOS supports configuring devices across PCI bridges, release 1.41 or greater of the ICU must be used with the motherboard to properly view and change system settings. System configuration information is stored in ESCD format. The ESCD data may be cleared by setting the CMOS clear jumper to the ON position .

The BIOS also has a setup option to support the Windows 95 run time plug and play utilities. When this option is selected, only devices critical to booting are assigned resources by the BIOS. Device Node information is available for all devices to ensure compatibility with Windows 95.

Copies of the IAL Plug and Play specification may be obtained via the Intel BBS, or via CompuServe by typing Go PlugPlay.

### 3.7 Advanced Power Management

The BIOS has support for Advanced Power Management (APM version 1.1). The energy saving Stand By mode can be initiated by a keyboard hot key sequence set by the user, a time-out period set by the user, or by a suspend/resume button tied to the front panel sleep connector.

When in Stand-by mode, the motherboard reduces power consumption by utilizing the Pentium processor's System Management Mode (SMM) capabilities and also spinning down hard drives and turning off VESA DPMS compliant monitors. The user may select which DPMS mode (Stand By, Suspend, or Off) send to the monitor in setup. The ability to respond to external interrupts is fully maintained while in Stand-by mode allowing the system to service requests such as in-coming Fax's or network messages while unattended. Any keyboard or mouse activity brings the system out of the energy saving Stand By mode. When this occurs the monitor and IDE drives are turned back on immediately.

APM is enabled in BIOS by default, however, the system must be configured with an APM driver in order for the system power saving features to take effect. Windows 95 will enable APM automatically upon detecting the presence of the APM BIOS.

### 3.8 Language Support

The BIOS setup screen and help messages are supported in 32 languages. There are 5 languages translated at this time for use; American English, German, Italian, French, and Spanish. Translations of other languages will available at a later date.

With a 1 Mb Flash BIOS, only one language can be resident at a time. The default language is American English, and will always be present unless another language is programmed into the BIOS using the Flash Memory Update Program (FMUP) available on the Intel BBS.

## 3.9 Boot Options

Booting from CD-ROM is supported in adherence to the “El Torito” bootable CD-ROM format specification developed by Phoenix Technologies and IBM. Under the *Boot Options* field in setup, *CD-ROM* is one of four possible boot devices which are defined in priority order. The default setting is for floppy to be the primary boot device and hard drive to be the secondary boot device. If CD-ROM is selected, it must be the first device. The third and fourth devices are set to *disabled* in the default configuration. The user can also select *network* as a boot device. The network option allows booting from a network add-in card with a remote boot ROM installed.

### ⇒ NOTE

*A copy of “El Torito” is available from Phoenix Web page (<http://www.ptltd.com/techs/specs.html>).*

## 3.10 Flash LOGO Area

The motherboard supports a 4 KB programmable FLASH user area located at EC000-ECFFF. An OEM may use this area to display a custom logo. The BIOS accesses the user area just after completing POST. A utility is available from Intel to assist with installing a logo into flash for display during POST. Contact your local Intel Sales office or authorized distributor for further information.

## 3.11 Setup Enable Jumper

A motherboard configuration jumper controls access to the BIOS Setup utility. By setting the jumper to the disable position, the user is prevented from accessing the Setup utility during the Power-on Self Test or at any other time. The message prompting the user to press <F1> to enter setup is also disabled.

## 3.12 BIOS Setup Utility

The ROM-based Setup utility allows the configuration to be modified without opening the system for most basic changes. The Setup utility is accessible only during the Power-on Self Test (POST) by pressing the <F1> key after the POST memory test has begun and before boot begins. A prompt may be enabled that informs users to press the <F1> key to access Setup. A jumper setting on the motherboard can be set to prevent user access to Setup for security purposes.

### 3.12.1 Overview of the Setup Menu Screens

The Setup program initially displays the Main menu screen. In each screen there are options for modifying the system configuration. Select a menu screen by pressing the left <←> or right <→> arrow keys. Use the up <↑> or down <↓> arrow keys to select items in a screen. Use the <Enter> key to select an item for modification. For certain items, pressing <Enter> will bring up a subscreen. After you have selected an item, use the arrow keys to modify the setting.

**Table 13. Overview of the Setup Menu Screens**

<b>Setup Menu Screen</b>	<b>Description</b>
Main	For setting up and modifying some of the basic options of a PC, such as time, date, diskette drives, hard drives.
Advanced	For modifying the more advanced features of a PC, such as peripheral configuration and advanced chipset configuration.
Security	For specifying passwords that can be used to limit access to the system.
Exit	For saving or discarding changes.
<b>Setup Subscreen</b>	<b>Description</b>
Floppy Options	For configuring your diskette drives.
Hard Disk Configuration	For configuring your hard drives.
Boot Options	For modifying options that affect the system boot up, such as the boot sequence.
Peripheral Configuration	For modifying options that affect the serial ports, the parallel port, and the disk drive interfaces.
Advanced Chipset Configuration	For modifying options that affect memory and system busses.
Power Management Configuration	For accessing and modifying Advanced Power Management (APM) options.
Plug and Play Configuration	For modifying options that affect the system's Plug and Play capabilities.

### 3.12.2 Main BIOS Setup Screen

This section describes the Setup options found on the main menu screen. If you select certain options from the main screen (e.g., Hard Disk), the Setup program switches to a subscreen for the selected option.

#### 3.12.2.1 System Date

Specifies the current date. Select the month from a pop-up menu.

#### 3.12.2.2 System Time

Specifies the current time. Type over the current time to set a new time.

#### 3.12.2.3 Floppy Options

When selected, this pops up the Floppy Options menu.

#### 3.12.2.4 Hard Disk C:, D:, E:, F:

Reports if a hard disk is connected to the system. When selected, this brings up the Hard Disk Configuration subscreen.

### **3.12.2.5 Language**

Specifies the language of the text strings used in the Setup program and the BIOS. The options are any installed languages.

### **3.12.2.6 Boot Options**

When selected, this brings up the Boot Options subscreen.

### **3.12.2.7 Video Mode**

Reports the video mode. There are no options.

### **3.12.2.8 Mouse**

Reports if a mouse is installed or not. There are no options.

### **3.12.2.9 Base Memory**

Reports the amount of base memory. There are no options.

### **3.12.2.10 Extended Memory**

Reports the amount of extended memory. There are no options.

### **3.12.2.11 BIOS Version**

Reports the version of the BIOS installed. There are no options.

## **3.12.3 Floppy Options Subscreen**

### **3.12.3.1 Floppy A:**

Reports if a diskette drive is connected to the system. There are no options.

### **3.12.3.2 Floppy B:**

Reports if a second diskette drive is connected to the system. There are no options.

### **3.12.3.3 Floppy A: Type**

Specifies the physical size and capacity of the diskette drive. The options are Disabled, 360 KB, 5.25-inch; 1.2 MB, 5.25-inch; 720 KB, 3.5-inch; 1.44/1.25 MB, 3.5-inch; 2.88 MB, 3.5-inch. The default is 1.44/1.25 MB, 3.5-inch.

### **3.12.3.4 Floppy B: Type**

Specifies the physical size and capacity of the diskette drive. The options are Disabled, 360 KB, 5.25-inch; 1.2 MB, 5.25-inch; 720 KB, 3.5-inch; 1.44/1.25 MB, 3.5-inch; 2.88 MB, 3.5-inch. The default is Disabled.



### 3.12.3.5 Floppy Access

Sets whether the floppy drive is writeable or not. The options are READ/WRITE or READ ONLY.

## 3.12.4 Hard Disk Configuration Subscreen

### 3.12.4.1 IDE Device Configuration

Used to manually configure the hard drive or have the system auto configure it. The options are Auto Configured and User Definable. The default is Auto Configured. If you select User Definable then the Number of Cylinders, Number of Heads, and Number of Sectors items can be modified.

### 3.12.4.2 Number of Cylinders

If Hard Disk Type is set to User Definable, you must type the correct number of cylinders for your hard disk. If Hard Disk Type is set to Auto Configured, this reports the number of cylinders for your hard disk and cannot be modified.

### 3.12.4.3 Number of Heads

If Hard Disk Type is set to User Definable, you must type the correct number of heads for your hard disk. If Hard Disk Type is set to Auto Configured, this reports the number of heads for your hard disk and cannot be modified.

### 3.12.4.4 Number of Sectors

If Hard Disk Type is set to User Definable, you must type the correct number of sectors for your hard disk. If Hard Disk Type is set to Auto Configured, this reports the number of sectors for your hard disk and cannot be modified.

### 3.12.4.5 Maximum Capacity

Reports the maximum capacity of your hard disk. It is calculated from the number of cylinders, heads, and sectors. There are no options here.

### 3.12.4.6 IDE Translation Mode

Specifies the IDE translation mode. The options are Standard CHS (standard cylinder head sector—less than 1024 cylinders), Logical Block, Extended CHS (extended cylinder head sector—greater than 1024 cylinders), and Auto Detected (BIOS detects IDE drive support for LBA). The default is Auto Detected.



#### **CAUTION**

*Do not change this from the option selected when the hard drive was formatted. Changing the option can result in corrupted data.*

### 3.12.4.7 Multiple Sector Setting

Sets the number of sectors transferred by an IDE drive per interrupt generated. The options are Disabled, 4 Sectors/Block, 8 Sectors/Block, or Auto Detected. The default is Auto Detected. Check the specifications for your hard disk drive to determine which setting provides optimum performance for your drive.

### 3.12.4.8 Fast Programmed I/O Modes

Sets how fast transfers on the IDE interface occur. The options are Disabled or Auto Detected. The default is Auto Detected. If set to Disabled, transfers occur at a less than optimized speed. If set to Auto Detected, transfers occur at the drive's maximum speed.

## 3.12.5 Boot Options Subscreen

This section describes the options available on the Boot Options subscreen.

### 3.12.5.1 First, Second, Third, Fourth Boot Device

Sets which drives the system checks to find an operating system to boot from. The following options are available:

First Boot Device: Select Disabled, Floppy, Hard Disk, CD-ROM, Network.

Second, Third, Fourth Device: Select Disabled, Floppy, Hard Disk, Network.

### 3.12.5.2 System Cache

Enables or disables both the primary and the secondary cache memory. The options are Enabled or Disabled. The default is Enabled.

### 3.12.5.3 Boot Speed

Sets the system's boot speed. The options are Deturbo and Turbo. The default is Turbo. If Turbo is selected, boot-up occurs at full speed. If Deturbo is selected, the board operates at a slower speed.

### 3.12.5.4 Num Lock

Sets the beginning state of the Num Lock feature on your keyboard. The options are On and Off. The default is Off.

### 3.12.5.5 Setup Prompt

Turns on (or off) the "Press <F1> Key if you want to run Setup" prompt during the power-up sequence. The options are Enabled and Disabled. The default is Enabled.

#### ⇒ **NOTE**

*This option has no effect on your ability to access the Setup program. It only toggles the prompt.*

### 3.12.5.6 Hard Disk Pre-delay

Sets the hard disk drive pre-delay. The options are Disabled, 3, 6, 9, 12, 15, 21 or 30 seconds. The default is 3 seconds. When enabled, this option causes the BIOS to wait the specified time before it accesses the first hard drive. If your system contains a hard drive, and you don't see the drive type displayed during boot-up, the hard drive may need more time before it is able to communicate with the controller. Setting a pre-delay provides additional time for the hard drive to initialize.

### 3.12.5.7 Typematic Rate Programming

Sets the typematic rates. The options are Default and Override. The default is Default. Choosing Override enables Typematic Rate Delay and Typematic Rate.

### 3.12.5.8 Typematic Rate Delay

Sets how long it takes for the key-repeat function to start when you hold down a key on the keyboard. The options are 250, 500, 750, and 1000 millisecond delays. The default is 250. If Typematic Rate Programming is set to Default, this option will not be visible.

### 3.12.5.9 Typematic Rate

Sets the speed at which characters repeat when you hold down a key on the keyboard. The higher the number, the faster the characters repeat. The options are 6, 8, 10, 12, 15, 20, 24, and 30 characters per second. The default is 6. If Typematic Rate Programming is set to Default, this option will not be visible.

## 3.12.6 Advanced Screen

This section describes the Setup options found on the Advanced menu screen. If you select certain options from the Advanced screen (e.g., Peripheral Configuration), the Setup program switches to a subscreen for the selected option. Subscreens are described in the sections following the description of the Advanced screen options.

### 3.12.6.1 Processor Type

Reports the CPU type. There are no options.

### 3.12.6.2 Processor Speed

Reports the CPU clock speed. There are no options.

### 3.12.6.3 Cache Size

Reports the size of the secondary cache. There are no options. If your system contains no L2 cache, this item will not appear.

### 3.12.6.4 Peripheral Configuration

When selected, this brings up the Peripheral Configuration subscreen.

### **3.12.6.5 Advanced Chipset Configuration**

When selected, this brings up the Advanced Chipset Configuration subscreen.

### **3.12.6.6 Power Management Configuration**

When selected and enabled, this brings up the Advanced Power Management subscreen.

### **3.12.6.7 Plug and Play Configuration**

When selected, this brings up the Plug and Play Configuration subscreen.

## **3.12.7 Peripheral Configuration Subscreen**

This section describes the screens for the peripheral configuration subscreen.

### **3.12.7.1 Configuration Mode**

Enables you to choose between setting the peripheral configuration yourself, or having the system do it. The options are Auto and Manual. The default is Auto.

When Auto is selected, the system peripherals are automatically configured during power up. The options below for PCI IDE Interface, Floppy Interface, Serial Port 1 and Serial Port 2 Addresses, Serial Port 2 IR Mode, and the Parallel Port Address cannot be modified. The settings displayed for those options reflect the current state of the hardware.

### **3.12.7.2 PCI IDE Interface**

Enables or disables the PCI IDE hard disk interface. The options are Enabled and Disabled. The default is Enabled. (If Configuration Mode is set to Auto, this option cannot be modified.)

### **3.12.7.3 Floppy Interface**

Enables or disables the diskette drive interface. The options are Enabled and Disabled. The default is Enabled. (If Configuration Mode is set to Auto, this option cannot be modified.)

### **3.12.7.4 Serial Port 1 Address**

Selects the address of the serial port. The options are Disabled; COM1, 3F8h, IRQ4; and COM3, 3E8h, IRQ4. The default is COM1, 3F8h, IRQ4. If the Configuration Mode is set to Auto, the Setup program assigns the first free COM port (normally COM1, 3F8h, IRQ4) as the serial port 1 address, regardless of what is selected under the Serial Port 1 Address option. (If Configuration Mode is set to Auto, this option cannot be modified.)

### **3.12.7.5 Serial Port 2 Address**

Selects the address of the serial port. The options are Disabled; COM2, 2F8h, IRQ3 and COM3, 3E8h, IRQ4. The default is COM2, 2F8h, IRQ3. If the Configuration Mode is set to Auto, the Setup program assigns the first free COM port (normally COM2, 2F8h, IRQ3) as the serial port 2 address, regardless of what is selected under the Serial Port 2 Address option. (If Configuration Mode is set to Auto, this option cannot be modified.)

## ⇒ NOTE

*If either serial port address is set, the address it is set to will not appear in the options dialog box of the other serial port. If an ATI mach32\* or an ATI mach64\* video controller is active, the COM4, 2E8h address will not appear in the options dialog box of either serial port.*

### 3.12.7.6 Serial Port 2 IR Mode

Makes Serial Port 2 available to infrared applications. The options are Enabled and Disabled. The default is Disabled. (If Configuration Mode is set to Auto, this option cannot be modified.)

### 3.12.7.7 Parallel Port Address

Selects the address and IRQ of the parallel port. The options are Disabled; LPT3, 3BCh, IRQ7; LPT1, 378h, IRQ7; LPT2, 278, IRQ7; LPT3, 3BC, IRQ5; LPT1, 378h, IRQ5; and LPT2, 278h, IRQ5. The default is LPT1, 378h, IRQ7. If the Configuration Mode is set to Auto, the setup program assigns LPT1, 378h, IRQ7 as the parallel port address, regardless of what is selected under the Parallel Port Address option. (If Configuration Mode is set to Auto, this option cannot be modified.)

### 3.12.7.8 Parallel Port Mode

Selects the mode for the parallel port. The options are Compatible, Bi-directional, EPP, and ECP. The default is Compatible. Compatible means the parallel port operates in AT-compatible mode. Bi-directional means the parallel port operates in bi-directional PS/2-compatible mode. EPP and ECP mean the parallel port operates high-speed, bidirectionally. This option is not affected by the Configuration Mode field above.

## 3.12.8 Advanced Chipset Configuration Subscreen

This section describes the options available on the Advanced Chipset Configuration Subscreen.

### 3.12.8.1 Base Memory Size

Sets the size of the base memory. The options are 512 KB and 640 KB. The default is 640 KB.

### 3.12.8.2 ISA LFB Size

Sets the size of the linear frame buffer. The options are Disabled and 1 MB. The default is Disabled. If this is set to 1 MB, then the ISA LFB Base Address field will appear.

### 3.12.8.3 ISA LFB Base Address

Reports the base address of the LFB. There are no options. This field will not appear if the ISA LFB Size is set to Disabled.

### 3.12.8.4 Video Palette Snoop

Controls the ability of a primary PCI graphics controller to share a common palette with an ISA add-in video card. The options are Enabled and Disabled. The default is Disabled.

### **3.12.8.5 Latency Timer (PCI Clocks)**

Sets the length of time an agent on the PCI bus can hold the bus when another agent has requested the bus. Valid numbers are between 0 and 256. The default is 66.

### **3.12.8.6 Memory Error Correction**

Reports if error correction is supported by the memory modules installed. There are no options.

### **3.12.8.7 Bank 0 SIMM Detected**

Reports the type of memory found in the bank 0 SIMM slots. There are no options.

### **3.12.8.8 Bank 1 SIMM Detected**

Reports the type of memory found in the bank 1 SIMM slots. There are no options.

## **3.12.9 Power Management Configuration Subscreen**

This section describes the options available on the Power Management Subscreen.

### **3.12.9.1 Advanced Power Management**

Enables or disables the Advanced Power Management (APM) support in your system's BIOS. The options are Enabled and Disabled. The default is Disabled. Power Management will only work with APM-capable operating systems to manage power consumption in your system. If Advanced Power Management is set to Disabled, none of the fields in the Advanced Power Management subscreen will be visible.

### **3.12.9.2 IDE Drive Power Down**

Sets any IDE drives to spin down when the system goes into power managed mode. The options are Enabled and Disabled. The default is Enabled.

### **3.12.9.3 Inactivity Timer**

Sets how long the system must be inactive before it enters power managed mode. Enter the number of minutes. The range is 0 to 255 minutes. The default is 10 minutes.

### **3.12.9.4 Hot Key**

Sets the hot key that, when pressed while holding down the <Ctrl> and <Alt> keys, causes the system to enter power managed mode. All alphabetic keys are valid.

## **3.12.10 Plug and Play Configuration Subscreen**

This section describes the options found on the Plug and Play configuration subscreen.

### 3.12.10.1 Configuration Mode

Sets how the BIOS gets information about ISA cards that do not have Plug and Play capabilities. The options are Use Setup Utility and Use ICU (ISA Configuration Utility). The default is Use Setup Utility.

If Use ICU is selected, the BIOS will depend on run-time software to ensure that there are no conflicts between ISA boards with Plug and Play capabilities and those without. Only Boot With PnP OS will be visible.

### 3.12.10.2 Boot with PnP OS

Enables the PC to boot with an operating system capable of managing Plug and Play add-in cards. The options are None, Other, and Windows 95. The default is Windows 95.

### 3.12.10.3 ISA Shared Memory Size

Enables you to “unshadow” a block of the upper memory area. The options are Disabled, 16 KB, 32 KB, 48 KB, 64 KB, 80 KB, and 96 KB. The default is Disabled. If this is set to Disabled, the ISA Shared Memory Base Address (described below) will not be visible.

Shadowing is a technique that copies a block of memory from an add-in card’s ROM to the same address in system memory. This provides faster access and achieves higher performance. By default, all upper memory is shadowed.

### 3.12.10.4 ISA Shared Memory Base Address

Sets the base address for the ISA Shared Memory. The options are C8000h, CC000h, D0000h, D4000h, D8000h, and D0000h. The default is C8000h. This setting could affect the ISA Shared Memory Size item. The value entered in the ISA Shared Memory Size item cannot extend to the E0000h address. For example, if a size of 64K was selected, options D4000h, D8000h, and DC000h will not be available.

### 3.12.10.5 IRQ 3, 4, 5, 7, 9, 10, 11, 12

Sets the status of the IRQ. The options are Available and Used By ISA Card. The default is Available. The PCI auto-configuration code looks here to see if these interrupts are available for use by a PCI add-in board. If an interrupt is available, the PCI auto-configuration code can assign the interrupt to be used by the system. If your system contains an ISA agent that uses one of these interrupts, select Used By ISA Card for that interrupt.

#### ⇒ **NOTE**

*IRQ 3, 4, 5, and 7 may not be available in this option, depending on the setting chosen for the COM1, COM2 and parallel ports in the Peripheral Configuration Subscreen.*

### 3.12.11 Security Screen

This section describes the two access modes that can be set using the options found on the Security screen, and then describes the Security screen options themselves.

### 3.12.11.1 Administrative and User Access Modes

The options on the Security screen menu make it possible to restrict access to the Setup program by enabling you to set passwords for two different access modes: Administrative mode and User mode.

In general, Administrative mode has full access to the Setup options, whereas User mode has restricted access to the options. Thus, by setting separate Administrative and User passwords, a system administrator can limit who can change critical Setup values. The actual limitations depend on whether either the Administrative or User passwords or both are set. (See the table below for a description of how the passwords actually work together.)

To limit access to who can boot the system, set the User password. This is the password that the system asks for before booting. If only the Administrative password is set, the system boots up without asking for a password. If both passwords are set, you can enter either password to boot the system.

The following table shows the effects of setting the Administrative and User passwords. (The table is for reference only, and is not shown on the Security screen.) In the table, the statement “Can change a limited number of options” means you can change the system date and time, the power management hot key, the User password, the security hot key, and unattended start.

**Table 14. Administrative and User Password Functions**

Password Set	Administrative mode can . . .	User mode can . . .	Password Required During Boot Process
Neither	Can change all options*	Can change all options*	None
Administrative only	Can change all options	Can change a limited number of options	None
User only	N/A	Can change all options	User
Both	Can change all options	Can change a limited number of options	Administrative or User

\* If no password is set, any user can change all Setup options.

### 3.12.12 Security Screen Options

#### 3.12.12.1 User Password is

Reports if there is a User password set. There are no options.

#### 3.12.12.2 Administrative Password is

Reports if there is an Administrative password set. There are no options.

#### 3.12.12.3 Set User Password

Sets the User password. The password can be up to seven alphanumeric characters.



#### **3.12.12.4 Set Administrative Password**

Sets the Administrative password. The password can be up to seven alphanumeric characters.

#### **3.12.13 Exit Screen**

This section describes the different ways to exit and save or not save changes made in the Setup program.

##### **3.12.13.1 Exit Saving Changes**

Saves the changes to CMOS RAM and exits the Setup program. You can also press the <F10> key anywhere in the Setup program to do this.

##### **3.12.13.2 Exit Discarding Changes**

Exits the Setup program without saving any changes. This means that any changes made while in the Setup program are discarded and NOT SAVED. Pressing the <Esc> key in any of the four main screens will do this.

##### **3.12.13.3 Load Setup Defaults**

Resets all of the setup options to their defaults. You can also press the <F5> key anywhere in the Setup program to do this.

This selection loads the default Setup values from the ROM table.

##### **3.12.13.4 Discard Changes**

Discards any changes you made during the current Setup session without exiting the program. You can also press the <F6> key anywhere in the Setup program to do this.

This selection loads the CMOS RAM values that were present when the system was turned on.



## 4 Error Messages and Beep Codes

---

### 4.1 BIOS Beep Codes

Beeps	Error Message	Description
1	Refresh Failure	The memory refresh circuitry on the motherboard is faulty.
2	Parity Error	Parity is not supported on this product, will not occur.
3	Base 64 KB Memory Failure	Memory failure in the first 64 KB.
4	Timer Not Operational	Memory failure in the first 64 KB of memory, or Timer 1 on the motherboard is not functioning.
5	Processor Error	The CPU on the motherboard generated an error.
6	8042 - Gate A20 Failure	The keyboard controller (8042) may be bad. The BIOS cannot switch to protected mode.
7	Processor Exception Interrupt Error	The CPU generated an exception interrupt.
8	Display Memory Read/Write Error	The system video adapter is either missing or its memory is faulty. This is not a fatal error.
9	ROM Checksum Error	ROM checksum value does not match the value encoded in BIOS.
10	CMOS Shutdown Register Rd/Wrt Error	The shutdown register for CMOS RAM failed.

### 4.2 PCI Configuration Error Messages

The following PCI messages are displayed as a group with bus, device and function information.

```
<'NVRAM Checksum Error, NVRAM Cleared'>, \ ; String  
<'System Board Device Resource Conflict'>, \ ; String  
<'Primary Output Device Not Found'>, \ ; String  
<'Primary Input Device Not Found'>, \ ; String  
<'Primary Boot Device Not Found'>, \ ; String  
<'NVRAM Cleared By Jumper'>, \ ; String  
<'NVRAM Data Invalid, NVRAM Cleared'>, \ ; String  
<'Static Device Resource Conflict'>, \ ; String
```

The following messages chain together to give a message such as:

```
PCI I/O Port Conflict: Bus: 00, Device 0D, Function: 01
```

If and when more than 15 PCI conflict errors are detected the log full message is displayed.

```

<'PCI I/O Port Conflict:'>, \ ; String
<'PCI Memory Conflict: '>, \ ; String
<'PCI IRQ Conflict: '>, \ ; String
<' Bus '>, \ ; String
<', Device '>, \ ; String
<', Function '>, \ ; String
<',PCI Error Log is Full.'>, \ ; String
<'Floppy Disk Controller Resource Conflict '>, \ ; Text
<'Primary IDE Controller Resource Conflict '>, \ ; Text
<'Secondary IDE Controller Resource Conflict '>, \ ; Text
<'Parallel Port Resource Conflict '>, \ ; Text
<'Serial Port 1 Resource Conflict '>, \ ; Text
<'Serial Port 2 Resource Conflict '>, \ ; Text
    
```

### 4.3 BIOS Error Messages

<b>Error Message</b>	<b>Explanation</b>
8042 Gate - A20 Error	Gate A20 on the keyboard controller (8042) is not working. Replace the 8042.
Address Line Short!	Error in the address decoding circuitry on the motherboard.
Cache Memory Bad, Do Not Enable Cache!	Cache memory is defective. Replace it.
CH-2 Timer Error	Most AT systems include two timers. There is an error in timer 2.
CMOS Battery State Low	CMOS RAM is powered by a battery. The battery power is low. Replace the battery.
CMOS Checksum Failure	After CMOS RAM values are saved, a checksum value is generated for error checking. The previous value is different from the current value. Run AMIBIOS Setup.
CMOS System Options Not Set	The values stored in CMOS RAM are either corrupt or nonexistent. Run Setup.
CMOS Display Type Mismatch	The video type in CMOS RAM does not match the type detected by the BIOS. Run AMIBIOS Setup.
CMOS Memory Size Mismatch	The amount of memory on the motherboard is different than the amount in CMOS RAM. Run AMIBIOS Setup.
CMOS Time and Date Not Set	Run Standard CMOS Setup to set the date and time in CMOS RAM.
Diskette Boot Failure	The boot disk in floppy drive A: is corrupt. It cannot be used to boot the system. Use another boot disk and follow the screen instructions.
Display Switch Not Proper	The display jumper is not implemented on this product, this error will not occur.

continued ➡

**BIOS Error Messages (continued)**

<b>Error Message</b>	<b>Explanation</b>
DMA Error	Error in the DMA controller.
DMA #1 Error	Error in the first DMA channel.
DMA #2 Error	Error in the second DMA channel.
FDD Controller Failure	The BIOS cannot communicate with the floppy disk drive controller. Check all appropriate connections after the system is powered down.
HDD Controller Failure	The BIOS cannot communicate with the hard disk drive controller. Check all appropriate connections after the system is powered down.
INTR #1 Error	Interrupt channel 1 failed POST.
INTR #2 Error	Interrupt channel 2 failed POST.
Invalid Boot Diskette	The BIOS can read the disk in floppy drive A:, but cannot boot the system. Use another boot disk.
Keyboard Is Locked...Unlock It	The keyboard lock on the system is engaged. The system must be unlocked to continue.
Keyboard Error	There is a timing problem with the keyboard. Set the Keyboard option in Standard CMOS Setup to Not Installed to skip the keyboard POST routines.
KB/Interface Error	There is an error in the keyboard connector.
Off Board Parity Error	Parity error in memory installed in an expansion slot. The format is: OFF BOARD PARITY ERROR ADDR (HEX) = (XXXX) XXXX is the hex address where the error occurred.
On Board Parity Error	Parity is not supported on this product, this error will not occur.
Parity Error ????	Parity error in system memory at an unknown address.

**4.4 ISA NMI Messages**

<b>ISA NMI Message</b>	<b>Explanation</b>
Memory Parity Error at xxxxx	Memory failed. If the memory location can be determined, it is displayed as xxxxx. If not, the message is Memory Parity Error ????.
I/O Card Parity Error at xxxxx	An expansion card failed. If the address can be determined, it is displayed as xxxxx. If not, the message is I/O Card Parity Error ????.
DMA Bus Time-out	A device has driven the bus signal for more than 7.8 microseconds.

